

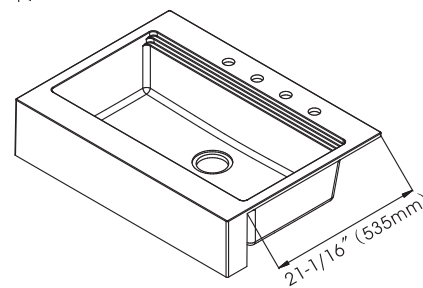

Model : 132-7302

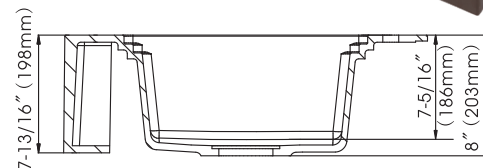
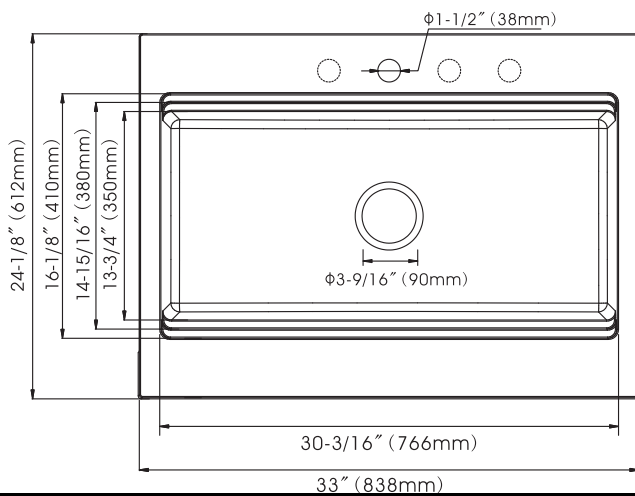

33" x 24" x 8" Top-Mount Single Bowl Flat Apron Front Farm Sink

Granite Composite Retrofit Work Station Kitchen Sink

- * cUPC Certified
- * Brown Finish
- * Scratch Resistant
- * Stain Resistant
- * Chip Resistant
- * Colorfast Throughout
- * One Faucet Hole Predrilled, Additional 3 Pre Scored Faucet Holes for use with 2, 3, or 4 Hole Faucet Styles
- * 1-1/2" (38mm) Hole Saw Included For Drilling Additional Faucet Holes
- * Mounting Hardware, Paper Cut-out Template (DXF File Available) and Installation Instructions Included
- * One Year Limited Warranty



Colander

Model : 132-6986

- * Ideal For Rinsing Food or Drying Dishes
- * Organize Your Sink Bowl Area
- * Built From Solid Stainless Steel to Provide Years of Use



Cutting Board

Model : 132-6985

- * Made of Durable Sapele
- * Cutting Board Fits Directly Over The Kitchen Sink
- * Easy To Clean



Drying Rack

Model : 132-6987

- * Stainless Steel with Rubber Joiner
- * Dishwasher Safe
- * Can Be Used for Air Drying or As A Hot Pad

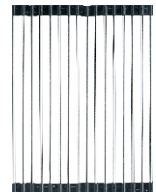

Corrosion Resistant Sink Grid

Model : 132-6988

- * Stainless Steel
- * Protect Sink Bowl from Scratches
- * Includes Rubber Feet, Side Bumpers, and Hole for Access to Sink Waste Hole

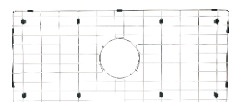

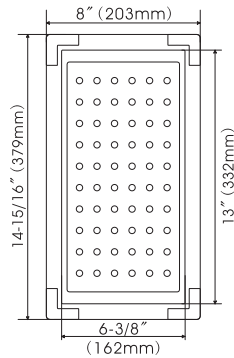

Colander

Model : 132-6986

- * Ideal For Rinsing Food or Drying Dishes
- * Organize Your Sink Bowl Area
- * Built From Solid Stainless Steel to Provide Years of Use

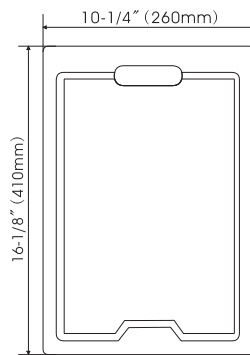
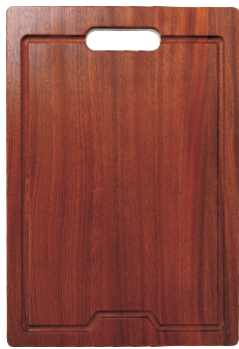

Cutting Board

Model : 132-6985

- * Made of Durable Sapele
- * Cutting Board Fits Directly Over The Kitchen Sink
- * Easy To Clean

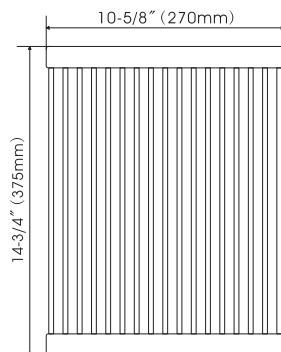
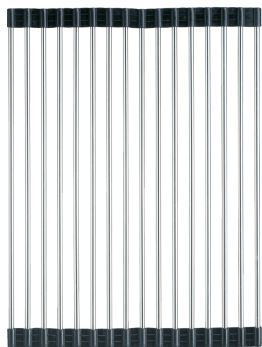

Drying Rack

Model : 132-6987

- * Stainless Steel with Rubber Joiner
- * Dishwasher Safe
- * Can Be Used for Air Drying or As A Hot Pad

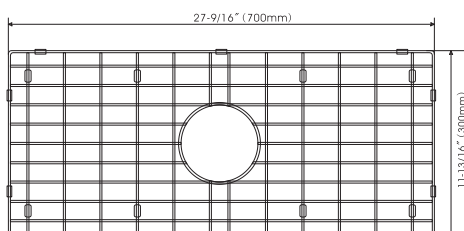
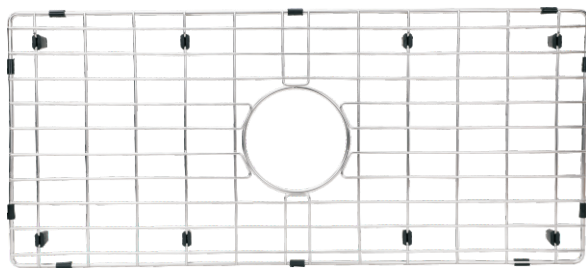

Corrosion Resistant Sink Grid

Model : 192-6988

- * Stainless Steel
- * Protect Sink Bowl from Scratches
- * Includes Rubber Feet, Side Bumpers, and Hole for Access to Sink Waste Hole