



LIMITED LIFETIME WARRANTY

Compass Manufacturing International warrants to the original consumer purchaser that the faucet be free from defects in material and workmanship for as long as the original consumer purchaser owns the home in which the faucet was first installed.

In the event that Freendo faucets are used in a Commercial Application, this warranty is limited for a period of 5 years, unless otherwise specifically stated in the catalog and/or price book.

Compass Manufacturing International will replace, free of charge, during the applicable warranty period, any part or finish that proves defective in material and/or workmanship under normal installation, use and service. This warranty shall not apply to goods which have been subject to accidents, negligence or improper installation. Compass Manufacturing International will not be liable for other damages or losses, including, but not limited to: labor charges and/or damages incurred in installation, repair or replacement as well as any other kind of loss or damage. Proof of purchase from the original consumer purchaser must be made available for all warranty claims.

Compass Manufacturing International recommends using a professional plumber for all installation and repair. Compass Manufacturing International will, at its discretion, provide new or equivalent replacement parts for any product that proves to be defective under normal usage and service. Replacement parts may be obtained by emailing the address below, calling the number below or by writing to:

Compass Manufacturing International
Freendo Product Service
6702 Enterprise Drive
Louisville, KY 40214
800.626.3525
warranty@cmiproduct.com

Revised 3/4/17

warranty@cmiproduct.com

© Compass Manufacturing International

800.626.3525



Model No. : 192-6452 Polished Chrome
192-6453 Brushed Nickel Spotless PVD
192-6454 Oil-Rubbed Bronze



Aegean Contractor Six Function Shower Only Trim Pack



Helpful Information

Helpful Tools

Tools:

Gather the necessary tools as shown below to complete the installation of this faucet. Some may not be needed depending on the model of faucet you are installing.



Plumber's Putty
and/or Silicone



Flashlight



Safety Glasses



Adjustable Wrench



Screwdriver



Pliers



Channel Locks

5

Parts List

15	Escutcheon Screw O-rings
14	Allen Key
13	Hot/Cold Button
12	Escutcheon Screw
11	Set Screw
10	Handle
9	Cartridge Locknut
8	Cartridge Sleeve
7	Cartridge
6	Escutcheon
5	Sealing Ring
4	Sealing Ring
3	Shower Head
2	Shower Arm
1	Shower Arm Flange
No.	Part Name

4

Show Diagram

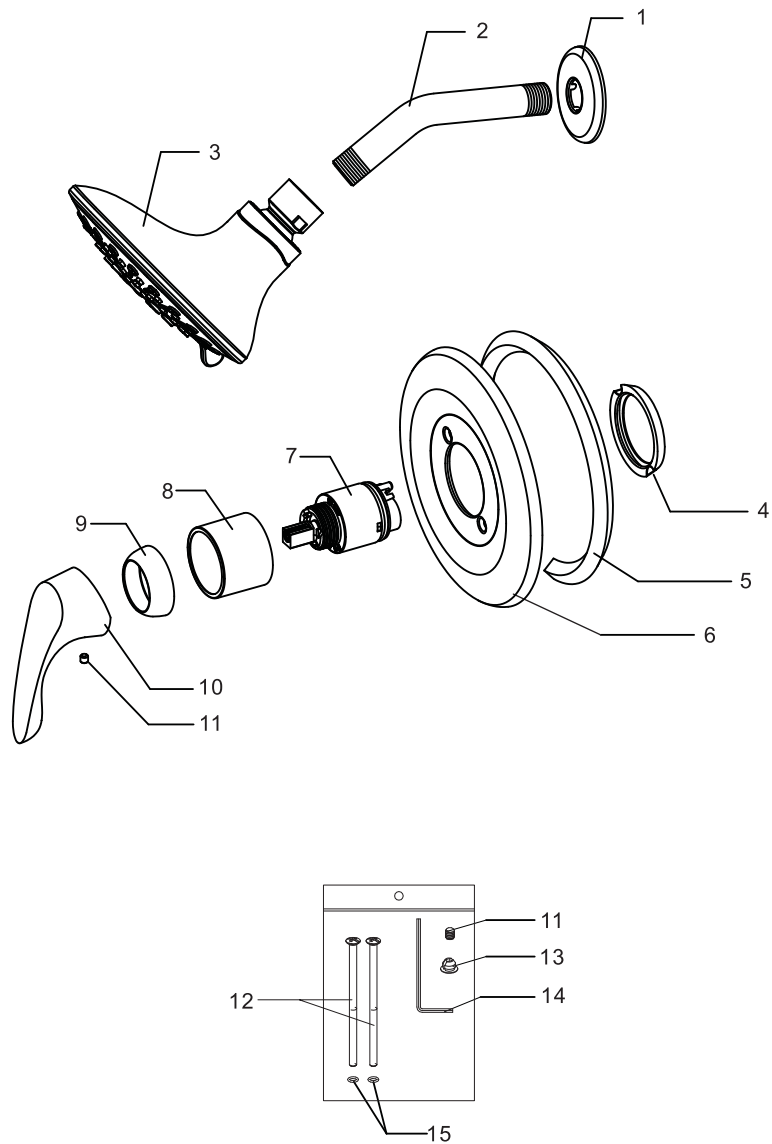
**1**

Faucet Installation

1.

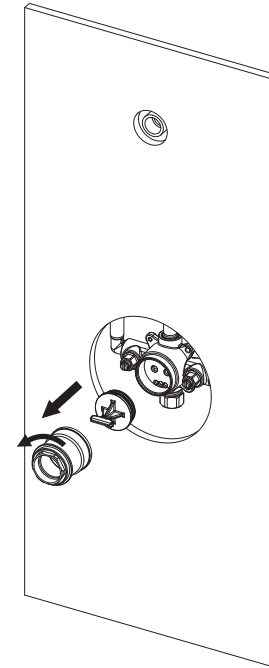

1. Remove the locknut sleeve, O-ring and test plug as shown.
 Note: DO NOT DISCARD locknut sleeve. This item is used to secure the cartridge.

2

Faucet Installation

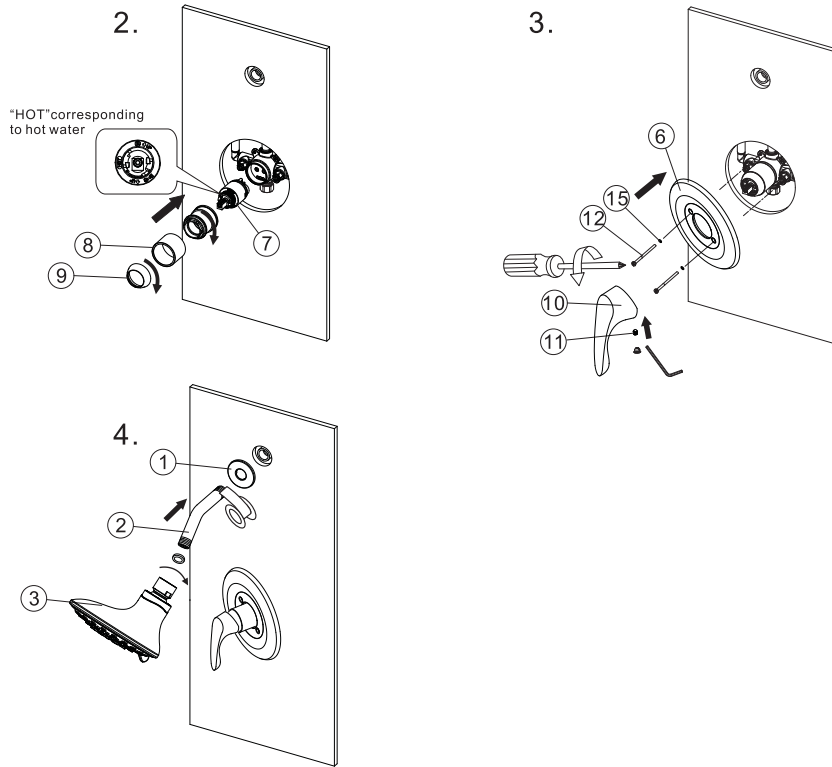

2. Install the cartridge (7), cartridge sleeve (8) and cartridge locknut (9) into the valve body.

3. Close bathtub drain to avoid losing parts. Install escutcheon (6) and secure it with escutcheon screws (12) and escutcheon screw o-rings (15). Make sure valve is in off position. Then assemble the handle (10) and secure it with set screw (11).

4. Apply teflon tape to two ends of shower arm (2) and install it to wall with shower arm flange (1). And connect the shower head (3) to shower arm (2).

CAUTIONS: ENSURE THE RUBBER WASHER IS IN POSITION BETWEEN THE SHOWER HEAD AND SHOWER ARM.

3

Configuration

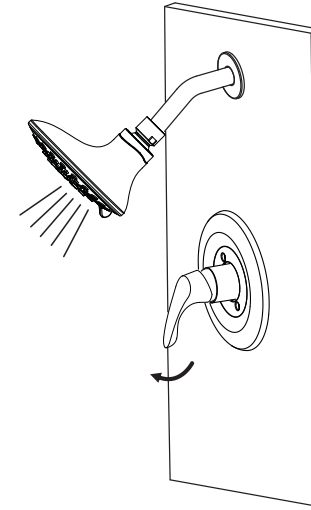

Turn on the water and check for leaks. If there are leaks, please reinstall.

Adjusting hot water stop.

Hot Water Adjustment

Position In The Middle Is Recommended

Cold Water Adjustment

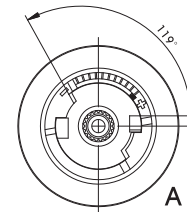

High Temperature setting
(Factory setting)

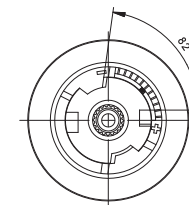

Average Temperature setting

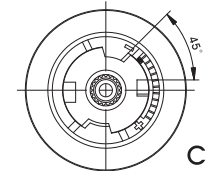

Low Temperature setting

By default, the temperature limiting device is set to the highest temperature (A). In order to reduce the temperature, remove the temperature limiting device and turn clockwise to the desired position (B or C).